

## Surface Mount Schottky Barrier Rectifier

Surface Mount Schottky Barrier Rectifier  
 Reverse Voltage - 45V  
 Forward Current - 5.0A

### FEATURES

- Metal silicon junction, majority carrier conduction
- For surface mounted applications
- Low power loss, high efficiency
- High forward surge current capability
- For use in low voltage, high frequency inverters, free wheeling, and polarity protection applications

### MECHANICAL DATA

- Case: SMBF
- Terminals: Solderable per MIL-STD-750, Method 2026
- Approx. Weight: 57mg / 0.002oz

### PINNING

PIN	DESCRIPTION
1	Cathode
2	Anode

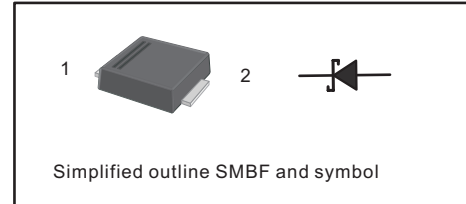

### Maximum Ratings and Electrical characteristics

Ratings at 25 °C ambient temperature unless otherwise specified.

Single phase half-wave 60 Hz, resistive or inductive load, for capacitive load current derate by 20 %.

Parameter	Symbols	SSL545BF	Units
Maximum Repetitive Peak Reverse Voltage	$V_{RRM}$	45	V
Maximum RMS voltage	$V_{RMS}$	32	V
Maximum DC Blocking Voltage	$V_{DC}$	45	V
Maximum Average Forward Rectified Current at $T_c=100\text{ }^\circ\text{C}$	$I_{F(AV)}$	5	A
Peak Forward Surge Current 8.3 ms Single Half Sine Wave Superimposed on Rated Load	$I_{FSM}$	150	A
Maximum Instantaneous Forward Voltage at 5 A	$V_F$	0.45	V
Maximum DC Reverse Current at Rated DC Blocking Voltage $T_a=25\text{ }^\circ\text{C}$ $T_a=100\text{ }^\circ\text{C}$	$I_R$	1 50	mA
Typical Junction Capacitance <sup>(1)</sup>	$C_j$	800	pF
Typical Thermal Resistance <sup>(2)</sup>	$R_{\theta JA}$	37	$^\circ\text{C/W}$
Operating Junction Temperature Range	$T_j$	-55 ~ +150	$^\circ\text{C}$
Storage Temperature Range	$T_{stg}$	-55 ~ +150	$^\circ\text{C}$

(1) Measured at 1 MHz and applied reverse voltage of 4 V D.C

(2) P.C.B. mounted with 2.0" X 2.0" (5 X 5 cm) copper pad areas.

**Fig.1 Forward Current Derating Curve**

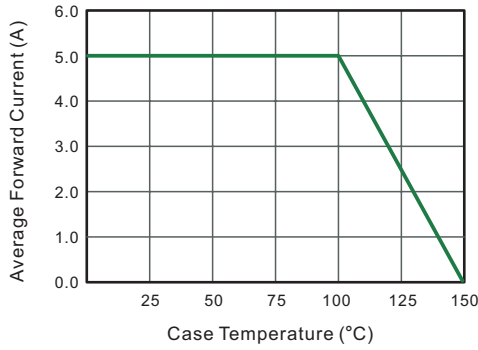

**Fig.2 Typical Reverse Characteristics**

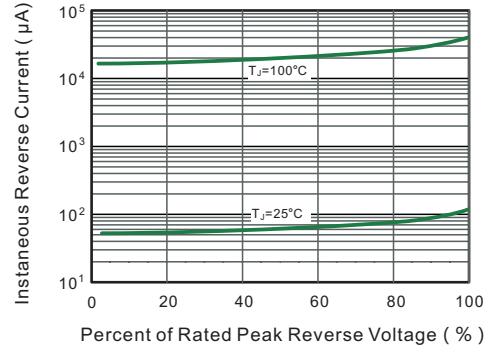

**Fig.3 Typical Forward Characteristic**

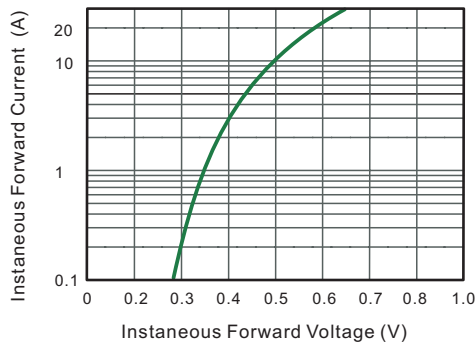

**Fig.4 Typical Junction Capacitance**

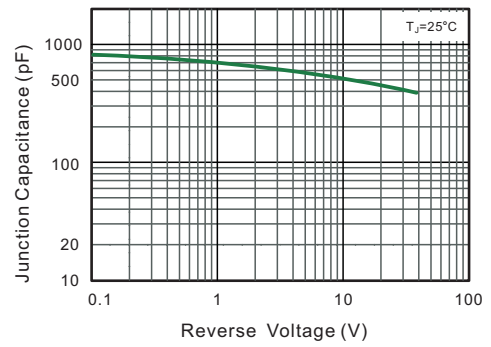

**Fig.5 Maximum Non-Repetitive Peak Forward Surge Current**

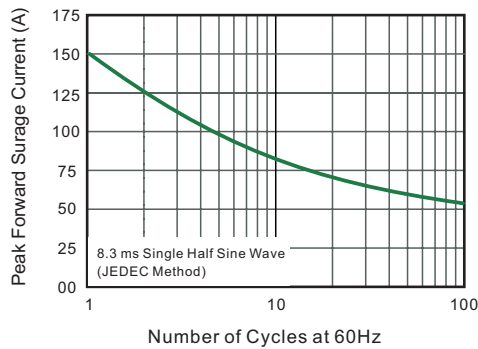

**Fig.6 Typical Transient Thermal Impedance**

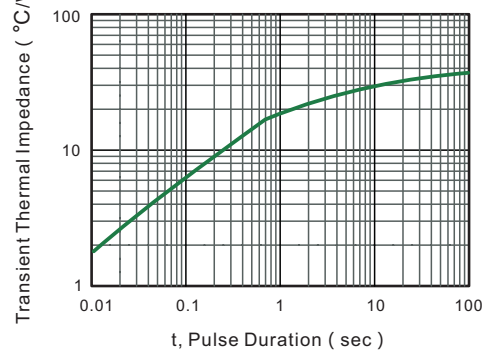

### PACKAGE OUTLINE

Plastic surface mounted package; 2 leads

SMBF

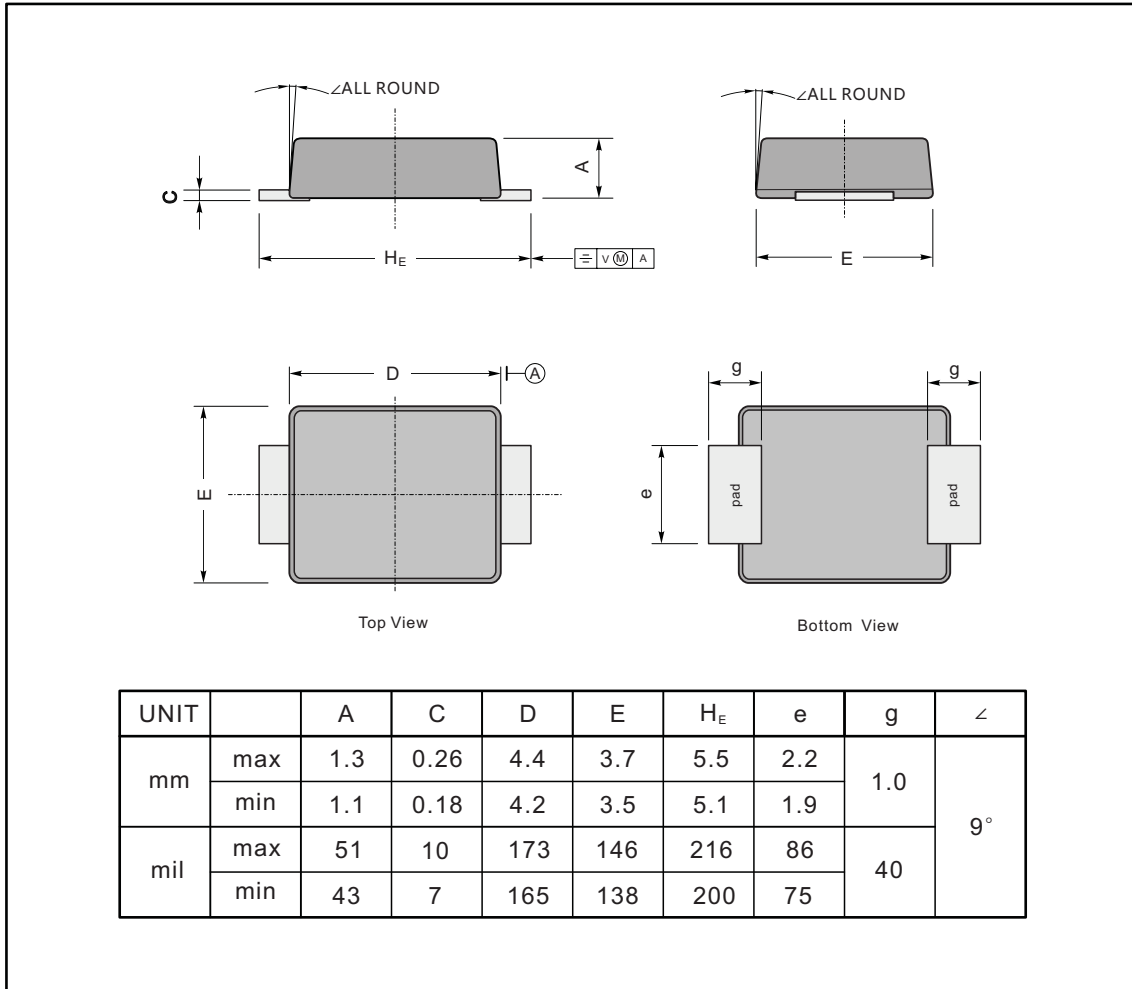

### The recommended mounting pad size

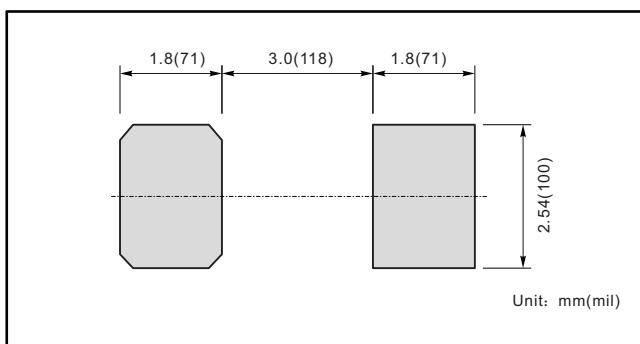

### Marking

Type number	Marking code
SSL545BF	S545B