

Surface Mount Schottky Barrier Rectifier  
 Reverse Voltage - 40 to 100V  
 Forward Current - 5.0A

### FEATURES

- Metal silicon junction, majority carrier conduction
- For surface mounted applications
- Low power loss, high efficiency
- High forward surge current capability
- For use in low voltage, high frequency inverters, free wheeling, and polarity protection applications

### MECHANICAL DATA

- Case: SMC
- Terminals: Solderable per MIL-STD-750, Method 2026
- Approx. Weight: 217mg / 0.0077oz

### PINNING

PIN	DESCRIPTION
1	Cathode
2	Anode

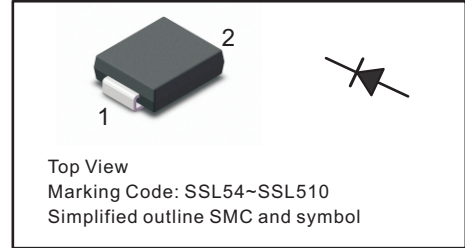

### Absolute Maximum Ratings and Electrical characteristics

Ratings at 25 °C ambient temperature unless otherwise specified. Single phase, half wave, 60Hz resistive or inductive load, for capacitive load, derate by 20 %

Parameter	Symbols	SSL54C	SSL545C	SSL55C	SSL56C	SSL510C	Units
Maximum Repetitive Peak Reverse Voltage	$V_{RRM}$	40	45	50	60	100	V
Maximum RMS voltage	$V_{RMS}$	28	32	35	42	70	V
Maximum DC Blocking Voltage	$V_{DC}$	40	45	50	60	100	V
Maximum Average Forward Rectified Current	$I_{F(AV)}$	5.0					A
Peak Forward Surge Current, 8.3ms Single Half Sine-wave Superimposed on Rated Load (JEDEC method)	$I_{FSM}$	150					A
Max Instantaneous Forward Voltage at 5 A	$V_F$	0.45		0.50		0.60	V
Maximum DC Reverse Current $T_a = 25^\circ\text{C}$ at Rated DC Reverse Voltage $T_a = 100^\circ\text{C}$	$I_R$	0.5 50					mA
Typical Junction Capacitance <sup>(1)</sup>	$C_j$	500	300				pF
Typical Thermal Resistance <sup>(2)</sup>	$R_{\theta JA}$	60					°C/W
Operating Junction Temperature Range	$T_j$	-55 ~ +150					°C
Storage Temperature Range	$T_{stg}$	-55 ~ +150					°C

(1) Measured at 1 MHz and applied reverse voltage of 4 V D.C

(2) P.C.B. mounted with 2.0" X 2.0" (5 X 5 cm) copper pad areas.

**Fig.1 Forward Current Derating Curve**

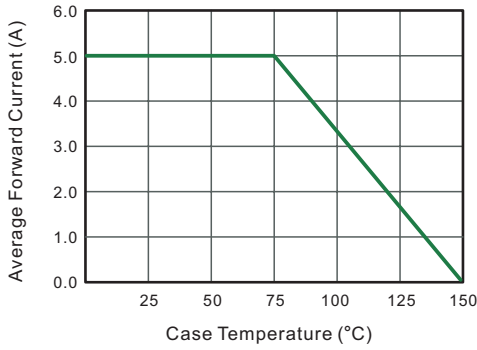

**Fig.2 Typical Reverse Characteristics**

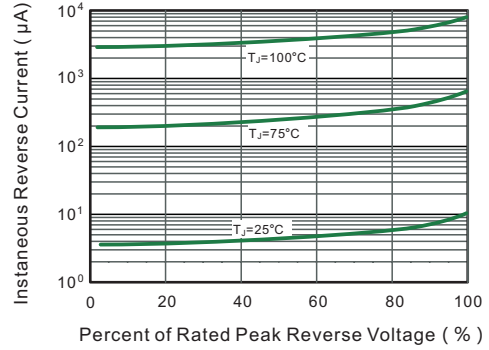

**Fig.3 Typical Forward Characteristic**

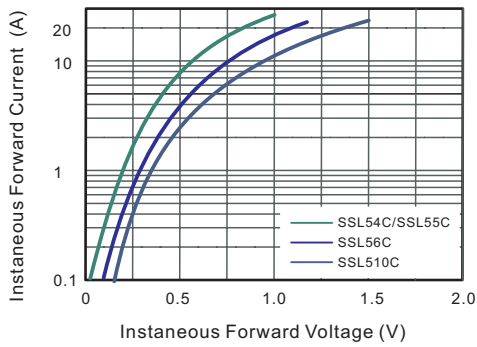

**Fig.4 Typical Junction Capacitance**

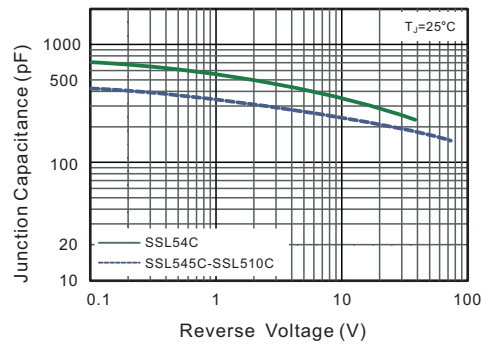

**Fig.5 Maximum Non-Repetitive Peak Forward Surge Current**

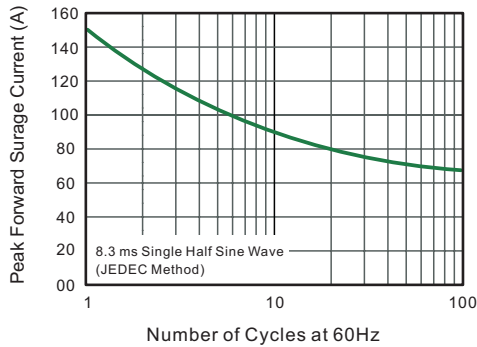

**Fig.6- Typical Transient Thermal Impedance**

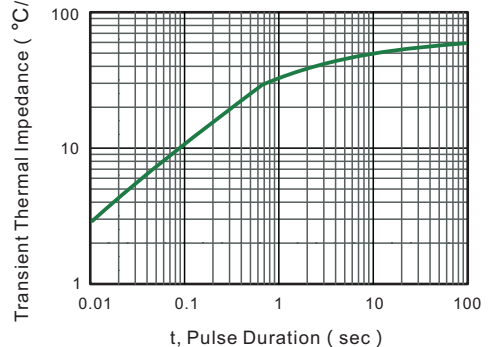

## PACKAGE OUTLINE

Plastic surface mounted package; 2 leads

SMC

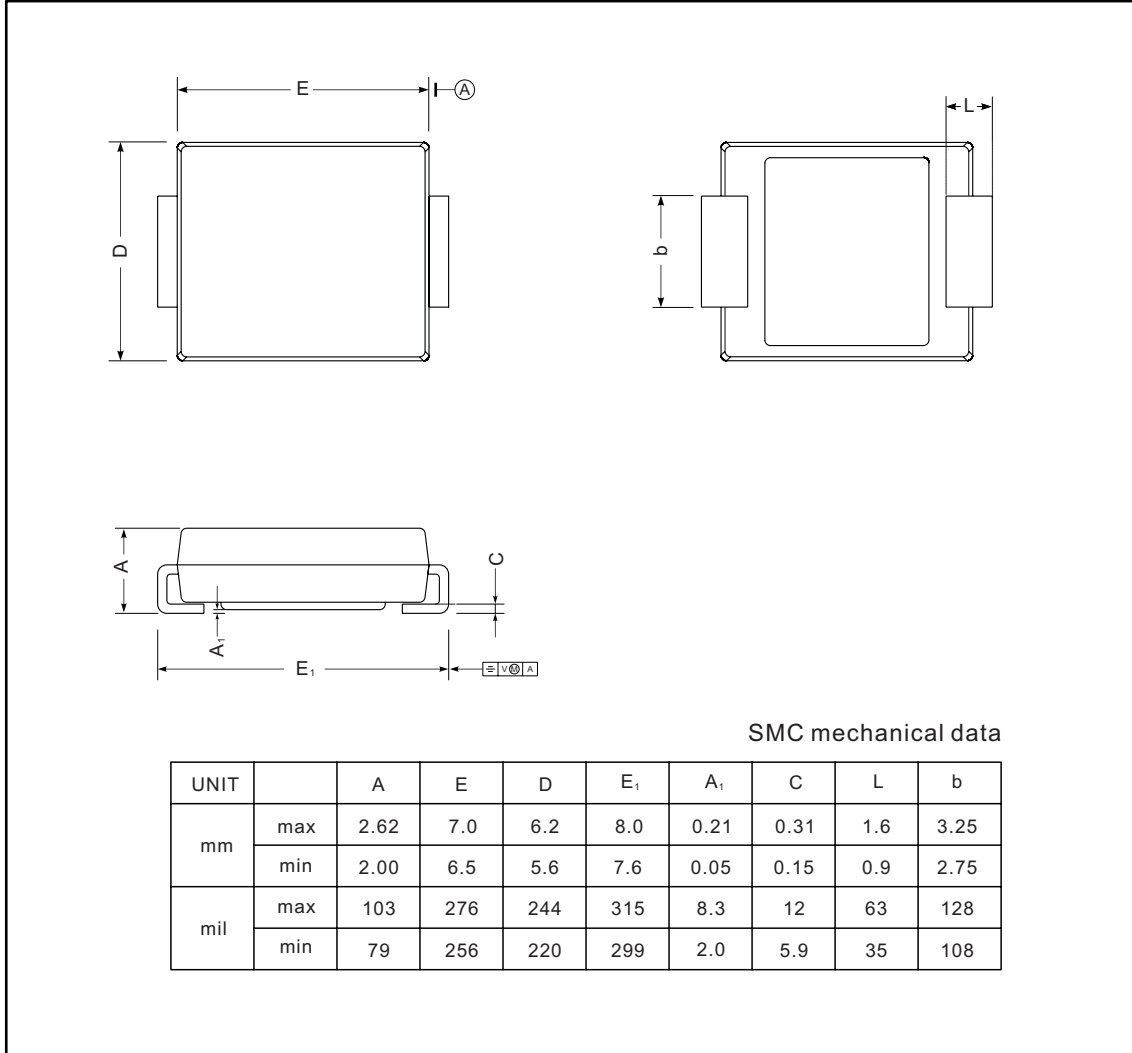

### The recommended mounting pad size

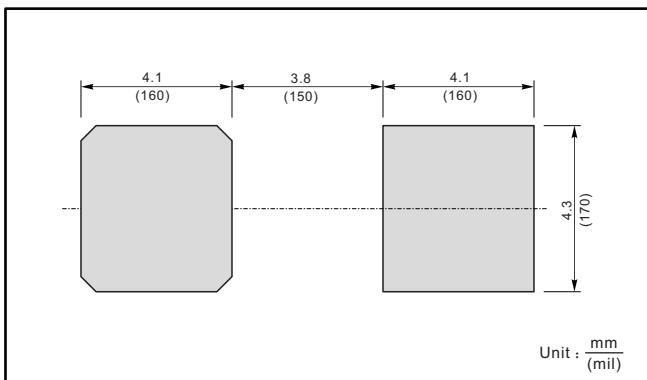

### Marking

Type number	Marking code
SSL54C	SSL54
SSL545C	SSL545
SSL55C	SSL55
SSL56C	SSL56
SSL510C	SSL510