

Surface Mount Schottky Barrier Rectifier

Reverse Voltage - 20 to 200V

Forward Current - 2.0A

FEATURES

- Metal silicon junction, majority carrier conduction
- For surface mounted applications
- Low power loss, high efficiency
- High forward surge current capability
- For use in low voltage, high frequency inverters, free wheeling, and polarity protection applications

MECHANICAL DATA

- Case: SMBF
- Terminals: Solderable per MIL-STD-750, Method 2026
- Approx. Weight: 57mg / 0.002oz

PINNING

PIN	DESCRIPTION
1	Cathode
2	Anode

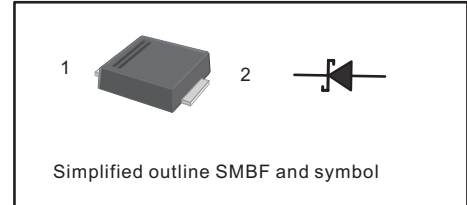

Absolute Maximum Ratings and Electrical characteristics

Ratings at 25 °C ambient temperature unless otherwise specified. Single phase, half wave, 60Hz resistive or inductive load, for capacitive load, derate by 20 %

Parameter	Symbols	SS22BF	SS24BF	SS26BF	SS28BF	SS210BF	SS212BF	SS215BF	SS220BF	Units
Maximum Repetitive Peak Reverse Voltage	V_{RRM}	20	40	60	80	100	120	150	200	V
Maximum RMS voltage	V_{RMS}	14	28	42	56	70	84	105	140	V
Maximum DC Blocking Voltage	V_{DC}	20	40	60	80	100	120	150	200	V
Maximum Average Forward Rectified Current	$I_{F(AV)}$	2.0								A
Peak Forward Surge Current, 8.3ms Single Half Sine-wave Superimposed on Rated Load (JEDEC method)	I_{FSM}	55				45				A
Max Instantaneous Forward Voltage at 2 A	V_F	0.55	0.70		0.85		0.95		V	
Maximum DC Reverse Current $T_a = 25^\circ\text{C}$ at Rated DC Reverse Voltage $T_a = 100^\circ\text{C}$	I_R	0.5 5			0.3 3				mA	
Typical Junction Capacitance ¹⁾	C_j	250			110				pF	
Typical Thermal Resistance ²⁾	$R_{\theta JA}$	65								°C/W
Operating Junction Temperature Range	T_j	-55 ~ +125								°C
Storage Temperature Range	T_{stg}	-55 ~ +150								°C

1) Measured at 1MHz and applied reverse voltage of 4 V D.C.

2) P.C.B. mounted with 0.5 X 0.5" (12.7 X 12.7 mm) copper pad areas.

Fig.1 Forward Current Derating Curve

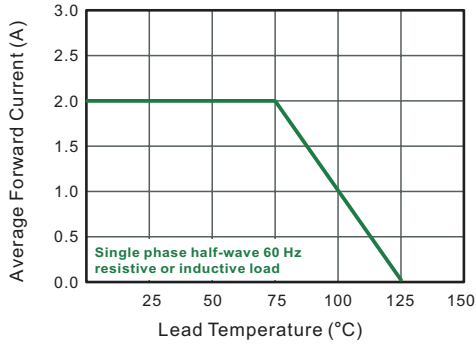

Fig.2 Typical Reverse Characteristics

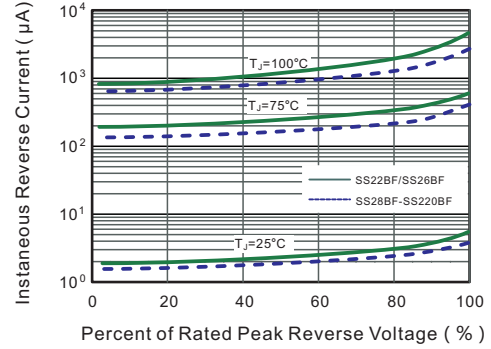

Fig.3 Typical Forward Characteristic

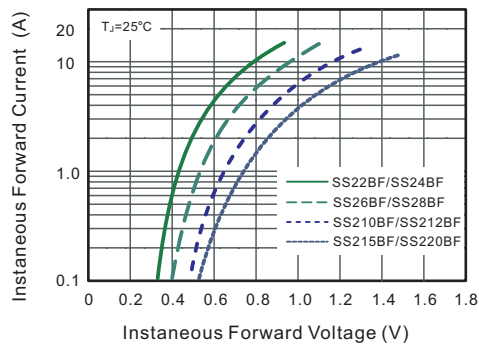

Fig.4 Typical Junction Capacitance

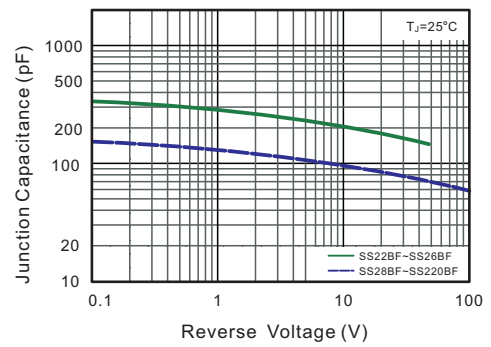

Fig.5 Maximum Non-Repetitive Peak Forward Surge Current

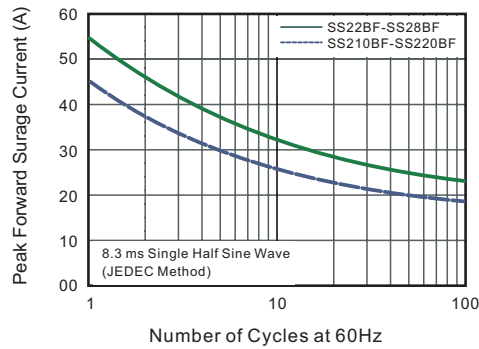
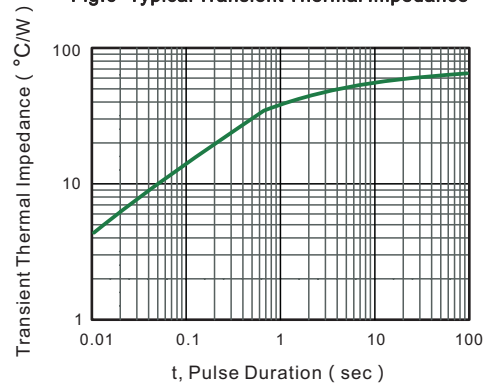

Fig.6- Typical Transient Thermal Impedance



PACKAGE OUTLINE

Plastic surface mounted package; 2 leads

SMBF

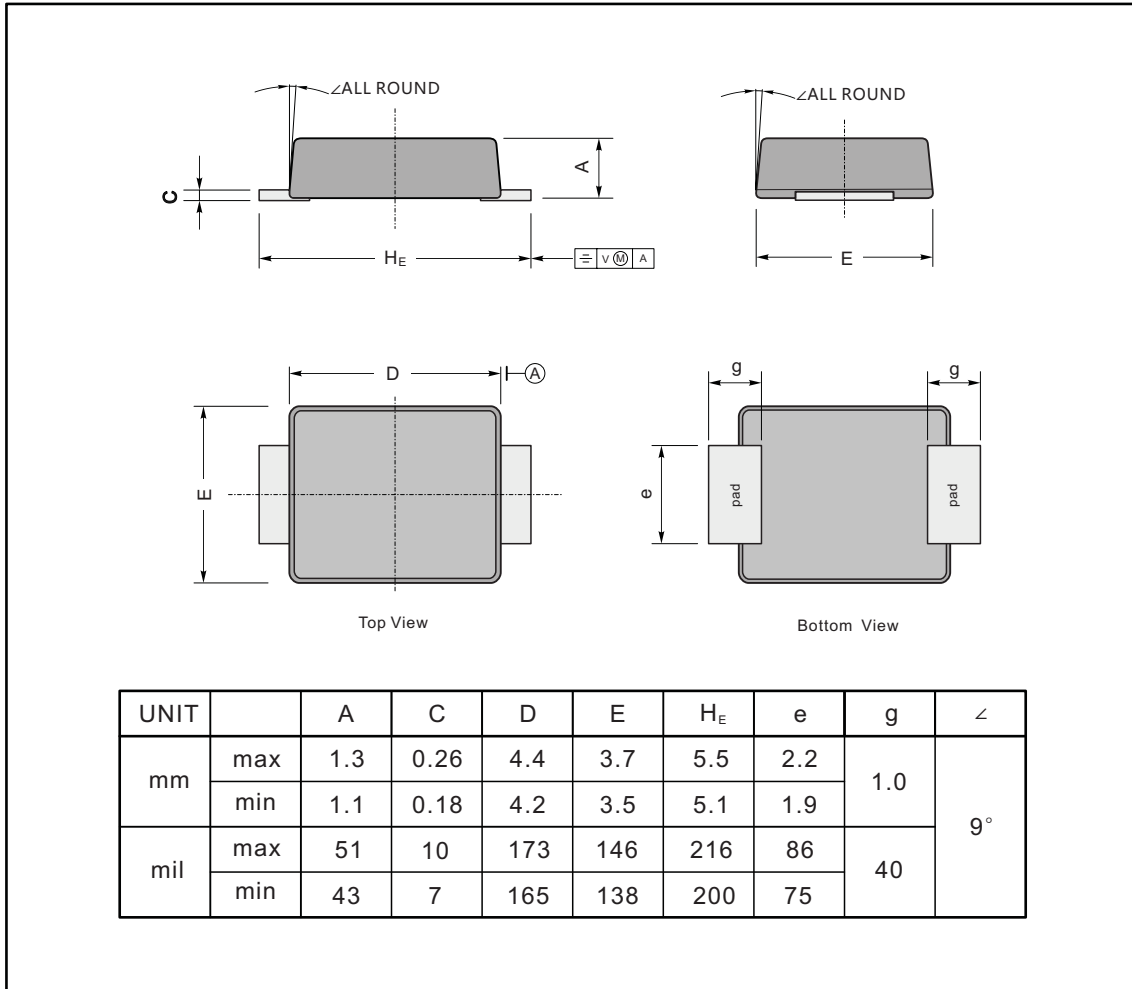

The recommended mounting pad size

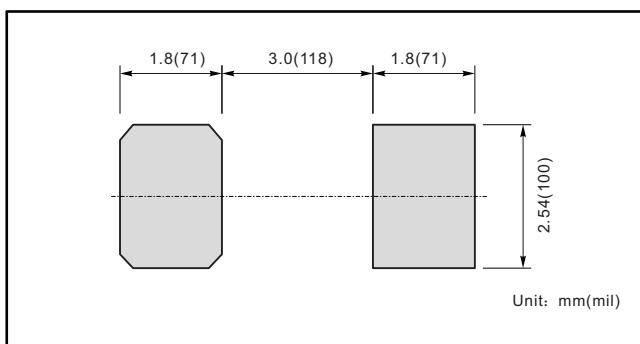

Marking

Type number	Marking code
SS22BF	S22B
SS24BF	S24B
SS26BF	S26B
SS28BF	S28B
SS210BF	S210B
SS212BF	S212B
SS215BF	S215B
SS220BF	S220B