

Surface Mount Schottky Barrier Rectifier

Reverse Voltage - 40 to 100 V

Forward Current - 3 A

FEATURES

- Metal silicon junction, majority carrier conduction
- For surface mounted applications
- Low power loss, high efficiency
- High forward surge current capability
- For use in low voltage, high frequency inverters, free wheeling, and polarity protection applications

MECHANICAL DATA

- Case: SMC
- Terminals: Solderable per MIL-STD-750, Method 2026
- Approx. Weight: 0.22g / 0.0077oz

PINNING

PIN	DESCRIPTION
1	Cathode
2	Anode

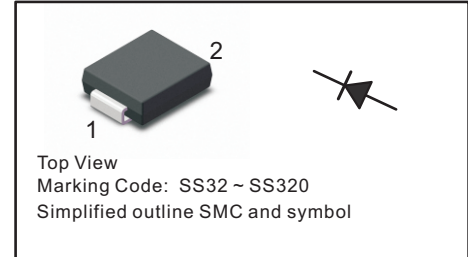

Maximum Ratings and Electrical characteristics

Ratings at 25 °C ambient temperature unless otherwise specified.

Single phase half-wave 60 Hz, resistive or inductive load, for capacitive load current derate by 20 %.

Parameter	Symbols	SS32C	SS34C	SS36C	SS38C	SS310C	SS312C	SS315C	SS320C	Units	
Maximum Repetitive Peak Reverse Voltage	V_{RRM}	20	40	60	80	100	120	150	200	V	
Maximum RMS voltage	V_{RMS}	14	28	42	56	70	84	105	140	V	
Maximum DC Blocking Voltage	V_{DC}	20	40	60	80	100	120	150	200	V	
Maximum Average Forward Rectified Current	$I_{F(AV)}$	3.0								A	
Peak Forward Surge Current, 8.3ms Single Half Sine-wave Superimposed on Rated Load (JEDEC method)	I_{FSM}	80								A	
Max Instantaneous Forward Voltage at 3 A	V_F	0.55		0.70		0.85		0.95		V	
Maximum DC Reverse Current $T_a = 25^\circ\text{C}$ at Rated DC Reverse Voltage $T_a = 100^\circ\text{C}$	I_R	0.5			0.3				5	3	mA
Typical Junction Capacitance ⁽¹⁾	C_j	450			350					pF	
Typical Thermal Resistance ⁽²⁾	$R_{\theta JA}$	50								°C/W	
Operating Junction Temperature Range	T_j	-55 ~ +125								°C	
Storage Temperature Range	T_{stg}	-55 ~ +150								°C	

(1) Measured at 1 MHz and applied reverse voltage of 4 V D.C

(2) P.C.B. mounted with 2.0" X 2.0" (5 X 5 cm) copper pad areas.

Fig.1 Forward Current Derating Curve

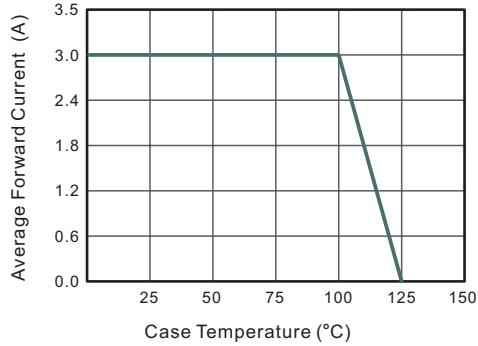

Fig.2 Typical Reverse Characteristics

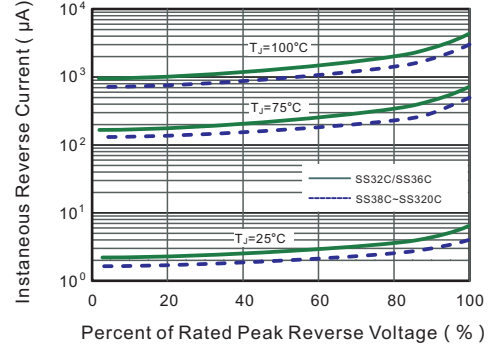

Fig.3 Typical Forward Characteristic

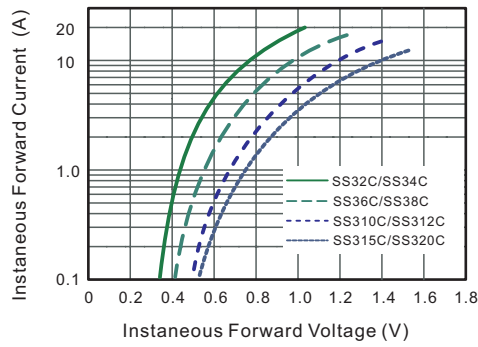

Fig.4 Typical Junction Capacitance

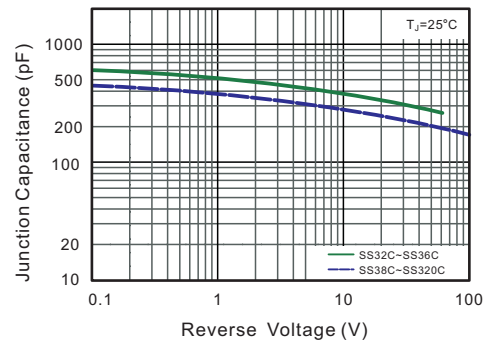

Fig.5 Maximum Non-Repetitive Peak Forward Surge Current

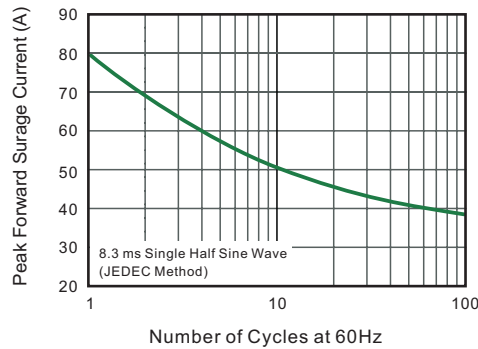
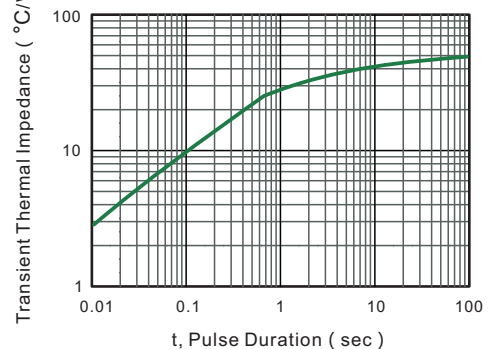

Fig.6- Typical Transient Thermal Impedance



PACKAGE OUTLINE

Plastic surface mounted package; 2 leads

SMC

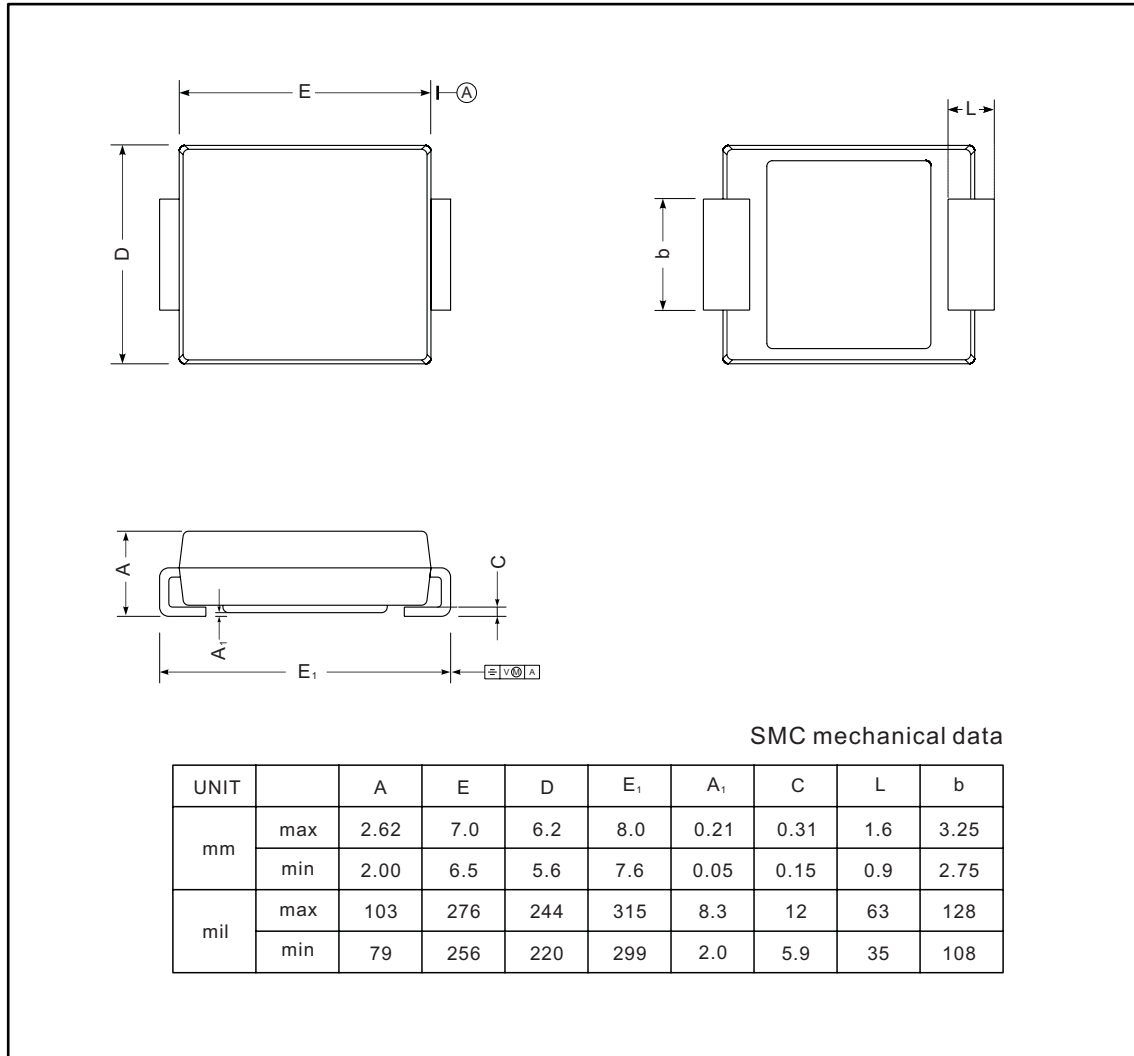

The recommended mounting pad size

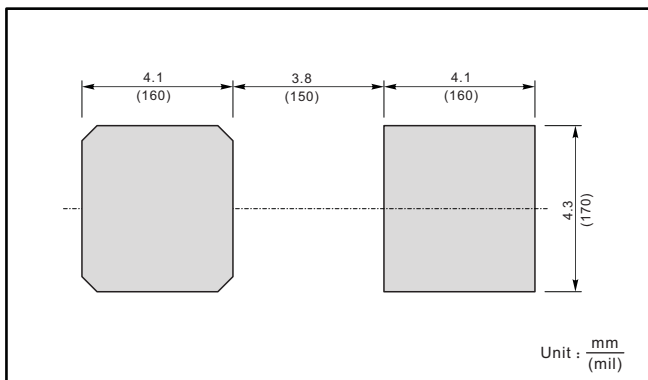

Marking

Type number	Marking code
SS32C	SS32
SS34C	SS34
SS36C	SS36
SS38C	SS38
SS310C	SS310
SS312C	SS312
SS315C	SS315
SS320C	SS320