

## Low Capacitance Bidirectional TVS/ESD Protection Diode

### DESCRIPTION

The GESD3B5CM is designed to protect voltage sensitive components from ESD and transient voltage events. Excellent clamping capability, low leakage, and fast response time, make these parts ideal for ESD protection on designs where board space is at a premium. Because of its small size, it is suited for use in cellular phones, portable devices, digital cameras, power supplies and many other portable applications where board space comes at a premium. Also because of its low capacitance, it is suited for use in high frequency designs such as high speed line applications.

This device has been specifically designed to protect sensitive components which are connected to data and transmission lines from overvoltage caused by ESD (electrostatic discharge), and EFT (electrical fast transients).

### FEATURES

- ✧ ESD per IEC 61000-4-2  $\pm 30$  kV (Contact)
- ✧ ESD per IEC 61000-4-2  $\pm 30$  kV (Air)
- ✧ IEC61000-4-4 (EFT) 40A (5/50ns)
- ✧ Peak power dissipation: 500W (8/20 $\mu$ s)
- ✧ Protects one Vcc or data line
- ✧ Low clamping voltage
- ✧ Working voltages: 5V
- ✧ Low leakage current
- ✧ Low capacitance

### MACHANICAL DATA

- ✧ SOD-323 package
- ✧ Flammability Rating: UL 94V-0
- ✧ High temperature soldering guaranteed:  
260°C/10s
- ✧ Packaging: Tape and Reel
- ✧ Reel size: 7 inch

### ORDERING INFORMATION

- ✧ Device: GESD3B5CM
- ✧ Package: SOD-323
- ✧ Marking: **5/S**
- ✧ Material: Halogen free and RoHS compliant
- ✧ Packing: Tape & Reel
- ✧ Quantity per reel: 3,000pcs

### APPLICATIONS

- ✧ Cell Phone Handsets and Accessories
- ✧ Microprocessor based equipment
- ✧ Personal Digital Assistants (PDA's)
- ✧ Notebooks, Desktops, and Servers
- ✧ Portable Instrumentation
- ✧ Networking and Telecom
- ✧ Serial and Parallel Ports
- ✧ Peripherals

### PIN CONFIGURATION

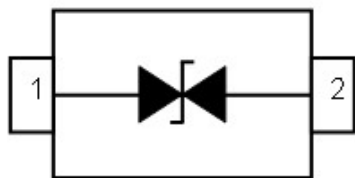

### PACKAGE OUTLINE



## ABSOLUTE MAXIMUM RATING

Symbol	Parameter	Value	Units
V <sub>ESD</sub>	ESD per IEC 61000-4-2 (Contact)	±30	kV
	ESD per IEC 61000-4-2 (Air)	±30	
P <sub>PP</sub>	Peak Pulse Power (8/20μs)	500	W
T <sub>OPT</sub>	Operating Temperature	-55~150	°C
T <sub>STG</sub>	Storage Temperature	-55~150	°C

## ELECTRICAL CHARACTERISTICS (T<sub>amb</sub>=25°C)

Symbol	Parameter	Test Condition	Min	Typ	Max	Units
V <sub>RWM</sub>	Reverse Working Voltage				5.0	V
V <sub>BR</sub>	Reverse Breakdown Voltage	I <sub>T</sub> = 1mA	5.8		7.8	V
I <sub>R</sub>	Reverse Leakage Current	V <sub>RWM</sub> = 5V			1.0	μA
V <sub>C</sub>	Clamping Voltage	I <sub>PP</sub> = 1A, t <sub>p</sub> = 8/20μs			9.8	V
V <sub>C</sub>	Clamping Voltage	I <sub>PP</sub> = 25A, t <sub>p</sub> = 8/20μs		15	20	V
C <sub>J</sub>	Junction Capacitance	V <sub>R</sub> = 0V, f = 1MHz			50	pF

## ELECTRICAL CHARACTERISTICS CURVE

Fig 1 8/20 $\mu$ s Waveform per IEC61000-4-5

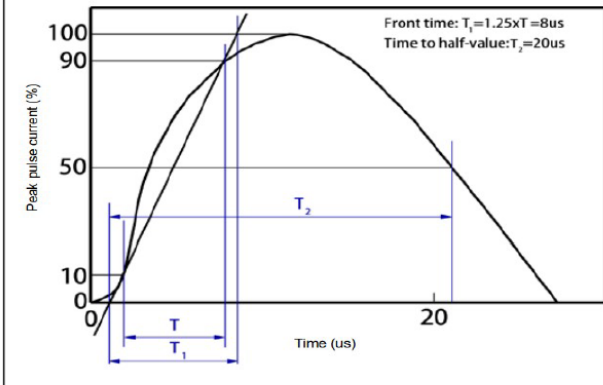

Fig 2 Contact Discharge Current Waveform per IEC 61000-4-2)

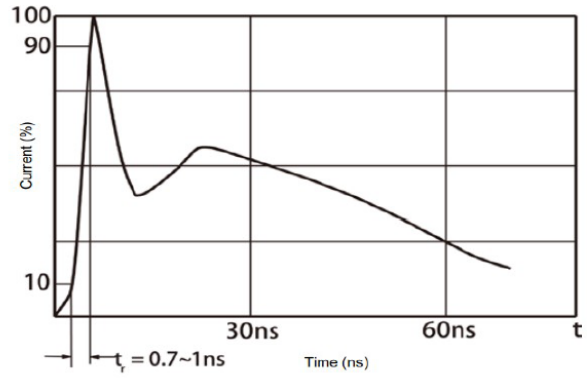

Fig 3 Voltage vs Capacitance

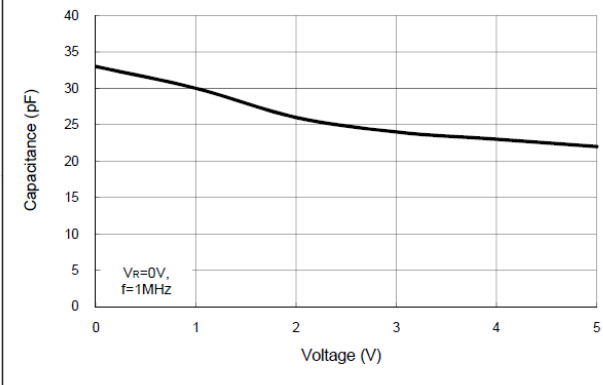
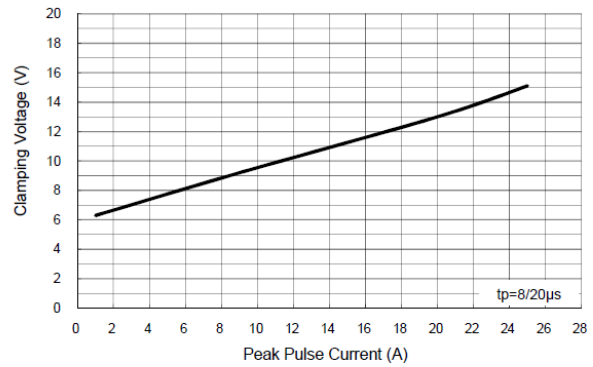
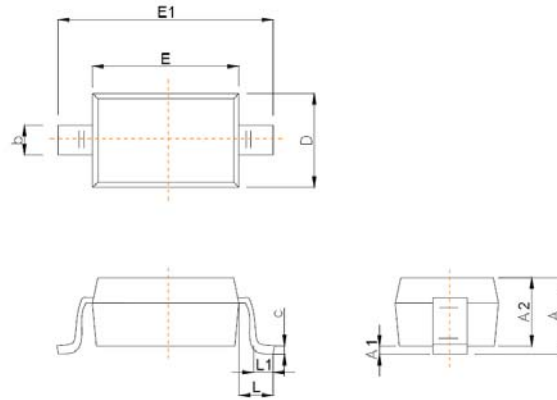

Fig 4 Peak Pulse Current vs Clamping Voltage



## SOD-323 PACKAGE OUTLINE DIMENSIONS



Symbol	Dimensions In Millimeters	
	Min	Max
A		1.00
A1	0.000	0.100
A2	0.800	0.900
b	0.250	0.350
c	0.080	0.150
D	1.200	1.400
E	1.600	1.800
E1	2.500	2.700
e	1.800	2.040
L	0.475 REF	
L1	0.250	0.400
θ	0°	8°

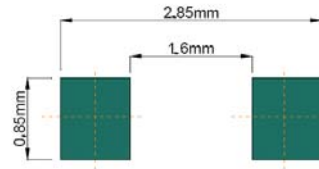

Recommended Pad outline